

6

5

4

3

2

1

APPROVED: \_\_\_\_\_

DATE: \_\_\_\_\_ TITLE: \_\_\_\_\_

Rev	AWO #	Description	Date	Appr
-		RELEASED	6/10/08	
A		REVISED INSULATOR DESIGN	8/18/08	
B		Revised wire type, added crimp terminals	11/06/08	
C		Changed Wire Terminal	11/24/08	
D		REMOVE TERMINAL	4/22/09	

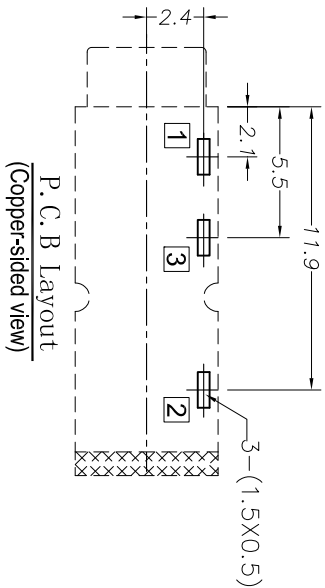
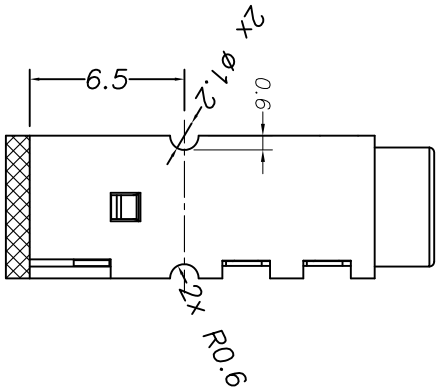
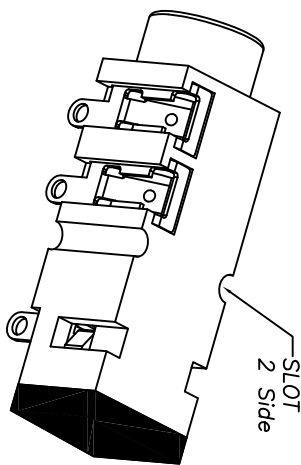
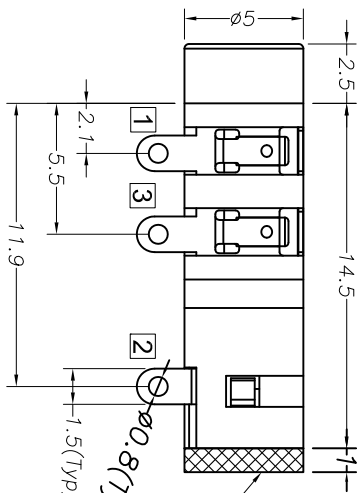
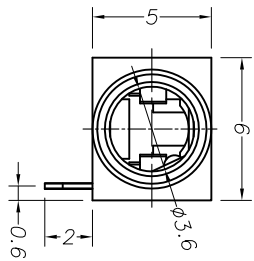

NOTE:  
1.0mm THICK SILICONE RUBBER GASKET  
MUST HAVE A 50% COMPRESSION RATIO  
(MUST BE ABLE TO BE COMPRESSED TO 0.5mm)

SCHEMATIC	WIRE COLOR
	BLK
	W/HT
	RED

**SPECIFICATIONS:**  
 Material: Insulator: PBT, Glass filled, rated UL 94V-0  
 Insulator color: Black  
 Gasket: Silicone Rubber  
 Contacts: Phosphor Bronze, Tin plated  
 Electrical:  
 Operating voltage: 30 VDC max.  
 Current rating: 0.5 Amp max.  
 Contact resistance: 30 mohms max, initial  
 Insulation resistance: 100 Mohms min.  
 Dielectric withstanding voltage: 500 VAC for 1 minute  
 Temperature Rating:  
 Operating temperature: -40°C to +125°C  
 Environmental:  
 Lead free, RoHS compliant.  
 Recommended soldering temp: 235°C for 5 sec.



UNLESS OTHERWISE SPECIFIED  
ALL DIMENSIONS ARE IN INCHES [MM]  
TOLERANCES, EXCEPT AS NOTED:  
INCHES                      HOLE'S

.X	± .10	Ø X	± .10
.XX	± .020	Ø XX	± .015
.XXX	± .015	Ø XXX	± .010

DATE: \_\_\_\_\_

**ADAM TECH**  
 909 Railway Avenue, Union, NJ 07083  
 Phone: 908-687-5000 Fax: 908-687-5710

TITLE: STEREO JACK, 3.5mm, THROUGH HOLE, NO TERMINALS

ASL-15-X-SP1

DRAWN	SS	6/10/08
CHECKED		
APPROVED		

SIZE	PART NO.	REV.
X	ASL-15-X-SP1	D
SCALE:	NTS	SHEET 1 OF 2

6

5

4

3

2

1

APPROVED: \_\_\_\_\_

DATE: \_\_\_\_\_ TITLE: \_\_\_\_\_

# ASSEMBLY

Rev	AWO #	Description	Date	Appr
		SEE SHT 1 OF 2 FOR REVISION HISTORY		

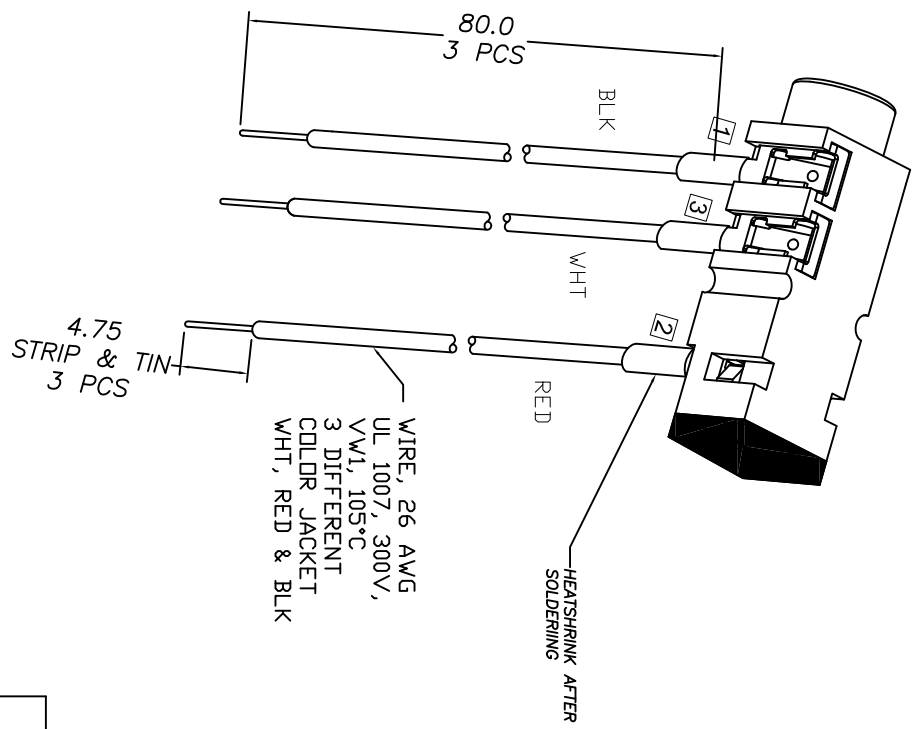
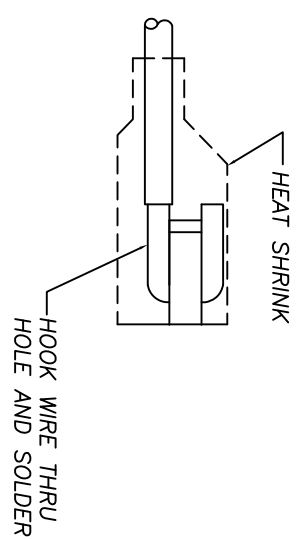

SCHEMATIC	
	BLK WIRE
	WHT WIRE
	RED WIRE

WHITE WIRE = LEFT CHANNEL  
 RED WIRE = RIGHT CHANNEL  
 BLACK WIRE = COMMON

**SPECIFICATIONS:**

**Material:**

Stereo Jack: Adam Tech P/N: ASJ-15-X-SP1

Wires: 26 Awg, UL 1007, 300V, 105°C, VW1 Rated,

Tinned Copper Conductors, Insulator colors Red, Black & White

Temperature Range: -10°C to +105°C

Heat Shrink: Polyolefin, color Black

**Environmental:**

Lead free, RoHS compliant.



UNLESS OTHERWISE SPECIFIED	
ALL DIMENSIONS ARE INCHES (MM)	
TOLERANCES: EXCEPT AS NOTED	
INCHES	HOLES
.X ± .10	Ø X ± .10
.XX ± .020	Ø XX ± .015
.XXX ± .015	Ø XXX ± .010
APPROVALS	DATE
DRAWN	SS
CHECKED	
APPROVED	

**ADAM TECH**  
 909 Rahway Avenue, Union, NJ 07083  
 Phone: 908-687-5000 Fax: 908-687-5710

TITLE: STEREO JACK, 3.5mm, THROUGH HOLE, NO TERMINALS

SIZE	PART NO.	REV.
X	ASJ-15-X-SP1	D
REF:	SCALE: NTS	SHEET 2 OF 2