

APPROVED: _____
 DATE: _____ TITLE: _____

Rev	AWO #	Description	Date	Appr
-		RELEASED	11/25/11	
A		REDRAWN	12/2/13	AY/NP
A		ADDED DIM.	9/1/16	AY/AT

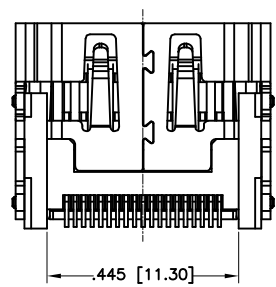

SPECIFICATIONS:
 Material:
 Insulator: Hi-Temp Thermoplastic, rated UL 94V-0
 Insulator color: Black
 Shield: Copper Alloy, Nickel Plated
 Contacts: Copper Alloy
 Plating:
 15u" Gold over Nickel underplate on contact area,
 Tin over Copper underplate on tails
 Electrical:
 Current rating: 0.5 A per pin.
 Voltage rating: 40 VAC
 Contact resistance: 60 mohms max.
 Insulation resistance: 100 Mohms min.
 Dielectric withstanding voltage: 500 VAC for 1 minute
 Temperature Rating:
 Operating temperature: -40°C to +85°C
 Environmental:
 Lead free, RoHS compliant.

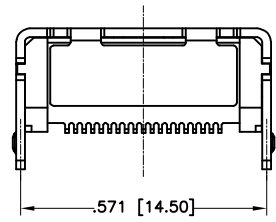
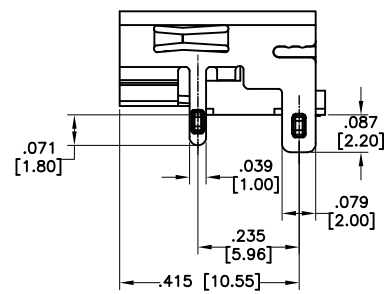
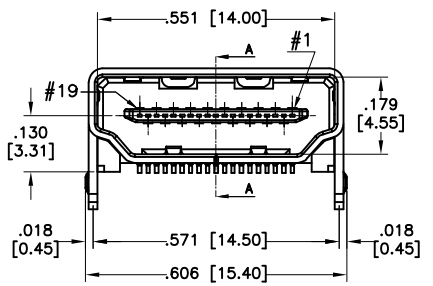
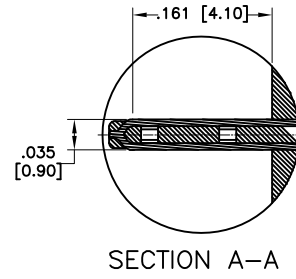
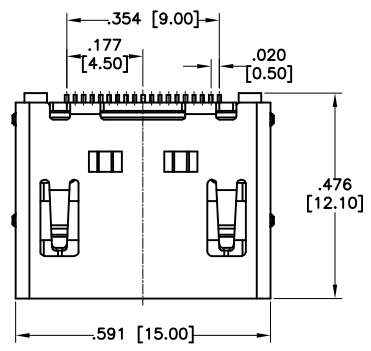
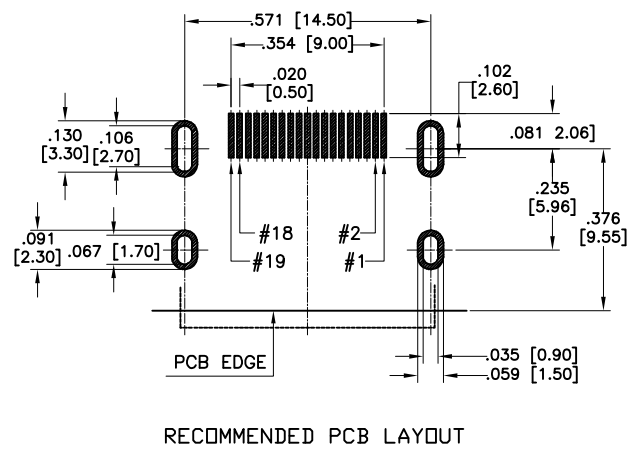

PACKAGED ON TAPE & REEL

UNLESS OTHERWISE SPECIFIED ALL DIMENSIONS ARE INCHES [MM] TOLERANCES: EXCEPT AS NOTED		
INCHES		HOLES
.X ± .10	ØX ± .10	
.XX ± .020	ØXX ± .015	
.XXX ± .015	ØXXX ± .010	
APPROVALS		DATE
DRAWN	AY	11/25/11
CHECKED	CC	11/25/11
APPROVED		

ADAM TECH
 909 Rahway Avenue, Union, NJ 07083
 Phone: 908-687-5000 Fax: 908-687-5710

TITLE: HDMI CONNECTOR, 19 POS, RIGHT ANGLE SURFACE MOUNT, 15u" SEL GOLD PLATED

SIZE	PART NO.	REV.
X	HDMI-S-RA-SMT-15-T/R	B

REF: S00009T SCALE: NTS SHEET 1 OF 1

6 5 4 3 2 1

6 5 4 3 2 1