

APPROVED: _____
 DATE: _____ TITLE: _____

Rev	AWO #	Description	Date	Appr
-		RELEASED	12/2/13	
A		ADDED DIM.	9/1/16	AY/AT

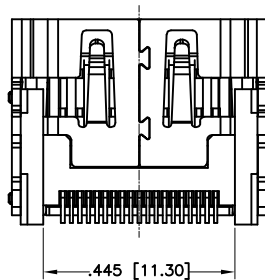
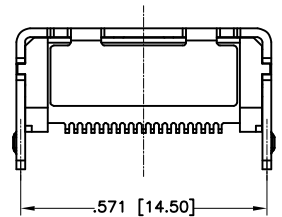
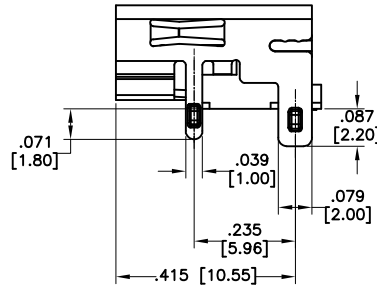
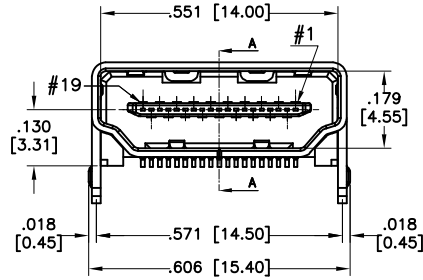
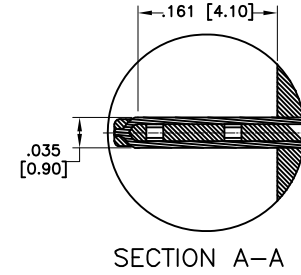
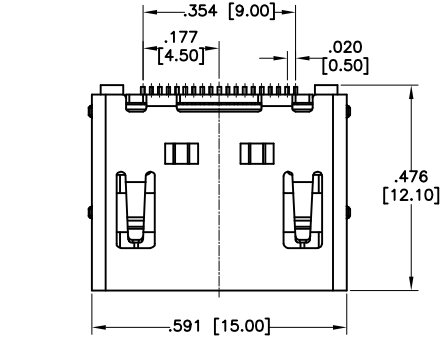
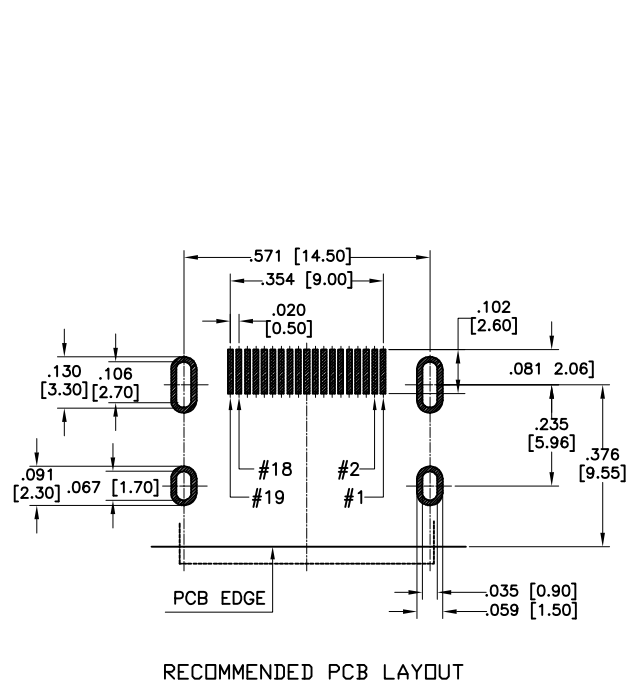

SPECIFICATIONS:

Material:
 Insulator: Hi-Temp Thermoplastic, rated UL 94V-0
 Insulator color: Black
 Shield: Copper Alloy, Nickel Plated
 Contacts: Copper Alloy
 Plating:
 Gold flash over Nickel underplate on contact area,
 Tin over Copper underplate on tails
 Electrical:
 Current rating: 0.5 A per pin.
 Voltage rating: 40 VAC
 Contact resistance: 60 mohms max.
 Insulation resistance: 100 Mohms min.
 Dielectric withstanding voltage: 500 VAC for 1 minute
 Temperature Rating:
 Operating temperature: -40°C to +85°C
 Environmental:
 Lead free, RoHS compliant.



PACKAGED ON TAPE & REEL

UNLESS OTHERWISE SPECIFIED ALL DIMENSIONS ARE INCHES [MM] TOLERANCES: EXCEPT AS NOTED		ADAM TECH 909 Rahway Avenue, Union, NJ 07083 Phone: 908-687-5000 Fax: 908-687-5710	
INCHES HOLES			
.X ± .10	Ø.X ± .10	TITLE HDMI CONNECTOR, 19 POS, RIGHT ANGLE SURFACE MOUNT, SEL GOLD PLATED	
.XX ± .020	Ø.XX ± .015		
.XXX ± .015	Ø.XXX ± .010		
APPROVALS		DATE	
DRAWN	AY	12/2/13	
CHECKED	NP	12/2/13	
APPROVED			
SIZE X	PART NO. HDMI-S-RA-SMT-T/R	REV. A	
REF: S00009T	SCALE: NTS	SHEET 1 OF 1	