

Rev	AWO #	Description	Date	Appr
-		RELEASED	10/30/09	

APPROVED: \_\_\_\_\_

DATE: \_\_\_\_\_ TITLE: \_\_\_\_\_

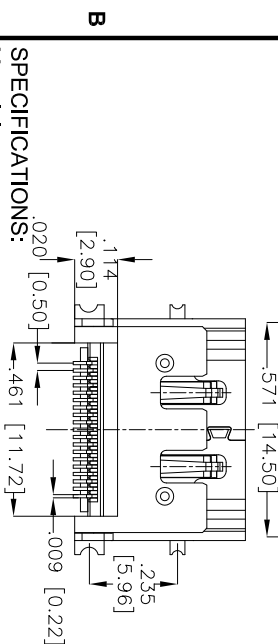
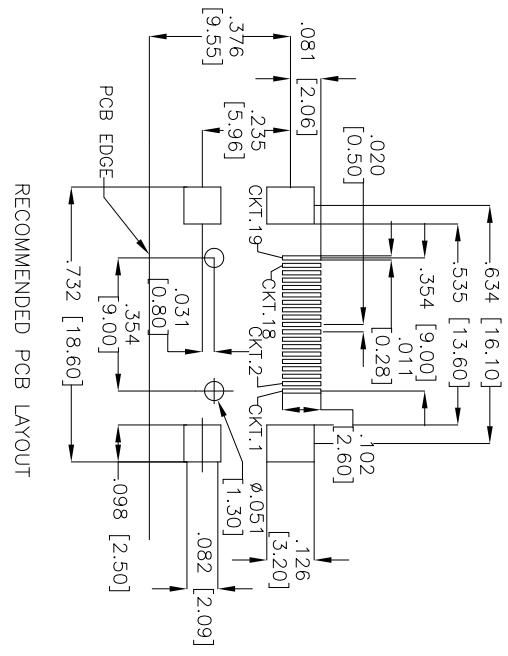
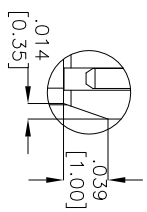
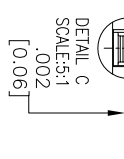
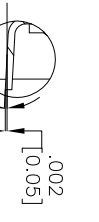
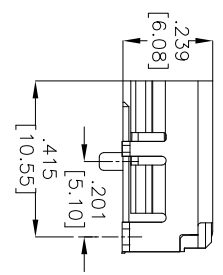
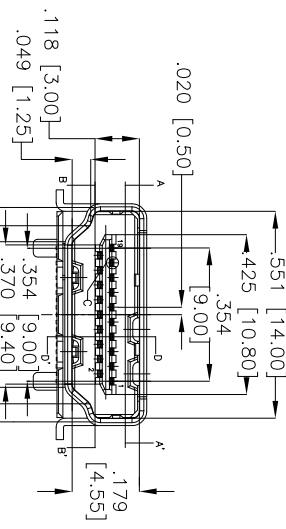
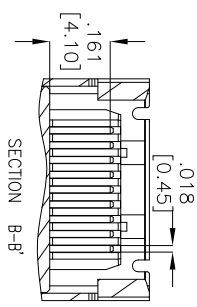
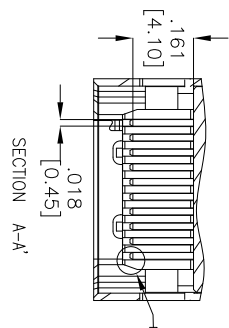
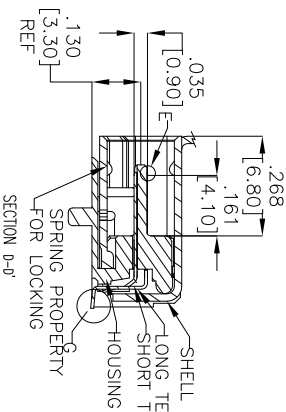
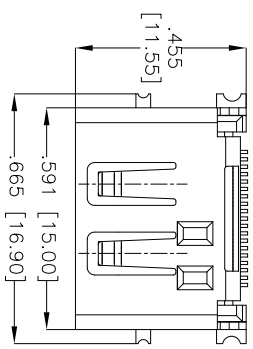

**SPECIFICATIONS:**

**Material:** Housing: Hi-temp thermoplastic, UL 94V-0  
 Housing color: Black  
 Contact: Copper Alloy  
 Shield: Copper Alloy  
 Plating: Gold flash over Nickel underplate on contact area, Tin over Copper underplate on tails.  
**Electrical:** Voltage rating: 40V  
 Current rating: 0.5A  
 Dielectric strength: 300VAC for 1 minute min.  
 Contact resistance: 100 Megohm min.  
 Contact resistance: 10 mohms max.  
**Environmental:** Lead free, RoHS Compliant  
 Recommended soldering temp: 260°C for 5 seconds.

**ADAM TECH**

DBA DONGGUAN TECONN ELECTRONICS TECHNOLOGY CO., Ltd

**HDMI CONNECTOR, RIGHT ANGLE**  
**SMT TYPE, HEADER ASSEMBLY**

UNLESS OTHERWISE SPECIFIED ALL DIMENSIONS ARE IN INCHES [MM] TOLERANCES: EXCEPT AS NOTED		HOLDERS	
.X	± .10	ØX	± .10
.XX	± .020	ØXX	± .015
.XXX	± .015	ØXXX	± .010
APPROVALS		DATE	
DRAWN	DY	10/30/09	
CHECKED			
APPROVED			

TITLE		SIZE	
HDMI CONNECTOR, RIGHT ANGLE		X	
SMT TYPE, HEADER ASSEMBLY		ENG. NO.	
		A111923-X	
PART NO.		SCALE: NTS	
HDMI-S-RA-TSMT-EU		SHEET 1 OF 1	
REV.			

