

Rev	AWO #	Description	Date	Appr
-		RELEASED	11/27/13	

APPROVED: _____
 DATE: _____ TITLE: _____

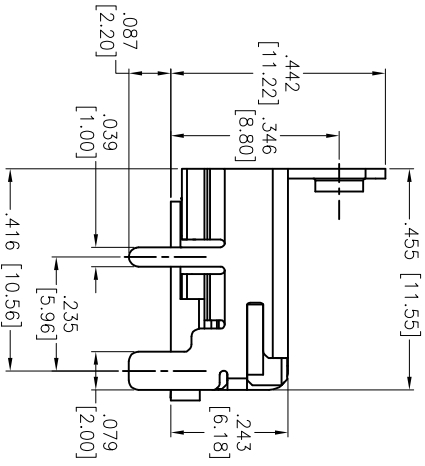
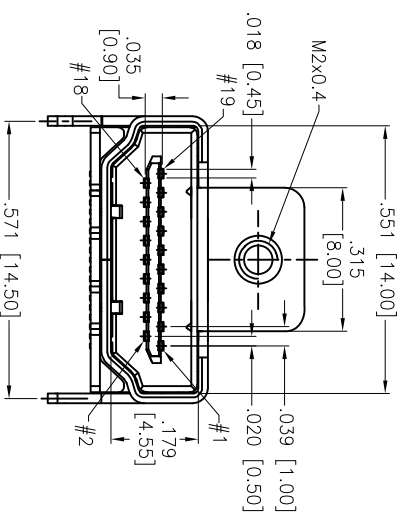
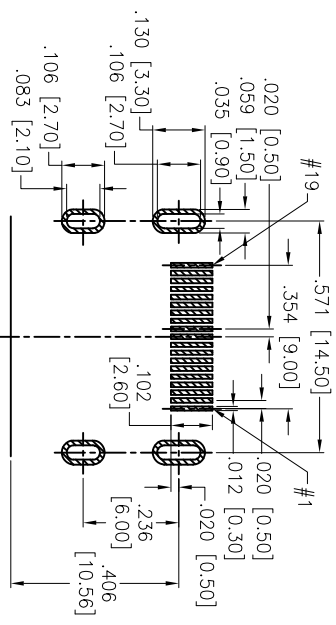
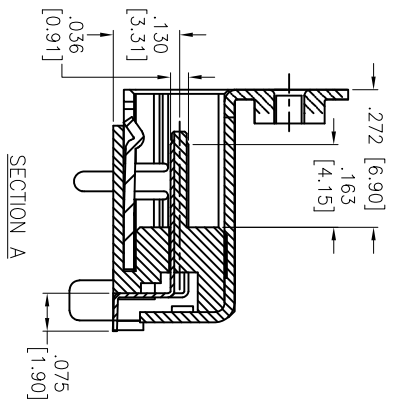
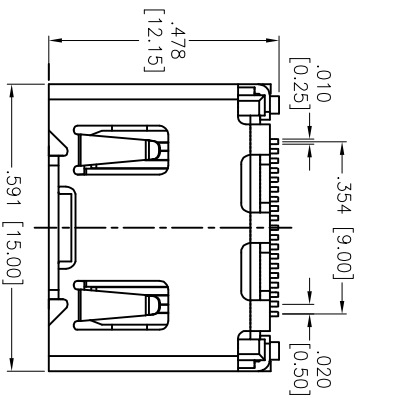

SPECIFICATIONS:
 Material: Insulator: Hi-Temp Thermoplastic, rated UL 94V-0
 Insulator color: Black
 Contacts: Brass
 Shield: Brass, Nickel plated
 Plating: Gold over Nickel underplate on contact area, Tin over Copper underplate on Solder tails.

Electrical:
 Operating voltage: 40V AC/DC
 Current rating: 0.5A DC Max.
 Contact resistance: 30 Mohms max
 Insulation resistance: 100 Mohms min @ 500 VDC
 Dielectric withstanding voltage: 500 VAC for 1 minute

Mechanical:
 Temperature Rating: Operating temperature: -25°C to +85°C
 Environmental: Lead free, RoHS compliant.

PACKAGED ON TAPE & REEL

UNLESS OTHERWISE SPECIFIED ALL DIMENSIONS ARE INCHES [MM]	
TOLERANCES: EXCEPT AS NOTED	
INCHES	HOLES
.X ± .10	Ø.X ± .10
.XX ± .020	Ø.XXX ± .015
.XXX ± .015	Ø.XXXX ± .010
APPROVALS	
DRAWN	HR
CHECKED	TW
APPROVED	DATE

ADAM TECH
 909 Ratway Avenue, Union, NJ 07083
 Phone: 908-687-5000 Fax: 908-687-5710

TITLE	HDMI CONNECTOR, RIGHT ANGLE, SURFACE MOUNT, NO PEG, FLANGE
SIZE	PART NO.
X	HDMI-S-RA4-SMT-MF-T/R
REF: S0097C	SCALE: NTS
2	SHEET 1 OF 2



APPROVED: _____
 DATE: _____ TITLE: _____

Rev	AWO #	Description	Date	Appr
-		RELEASED	11/27/13	

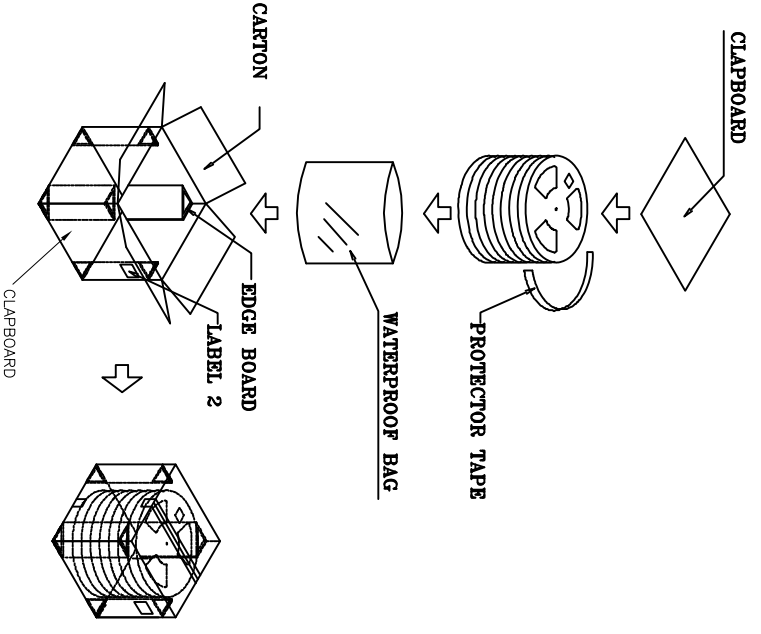
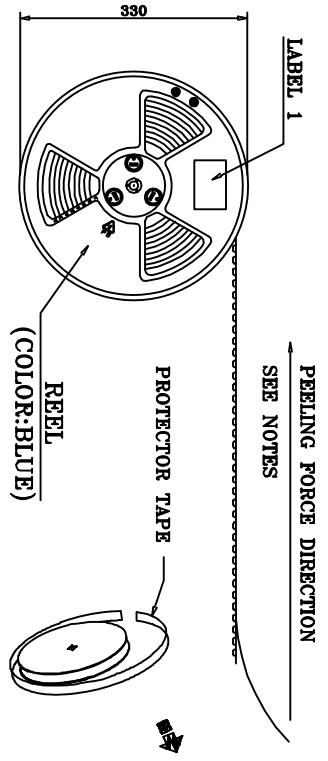
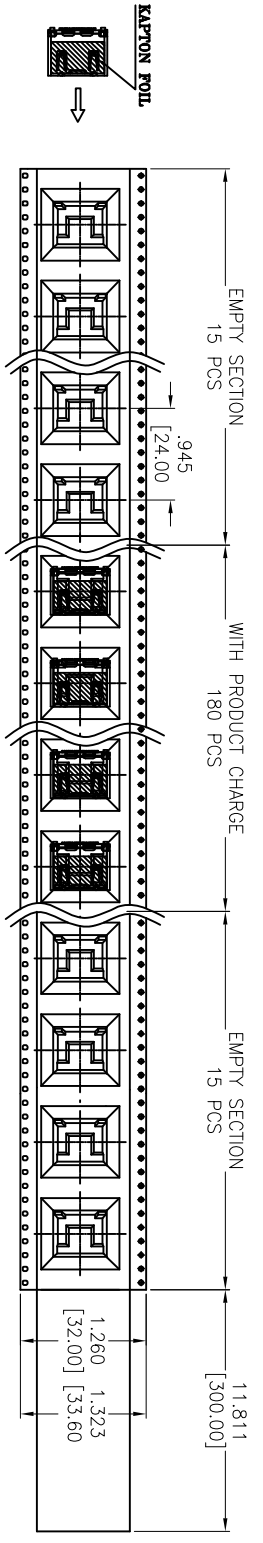

UNLESS OTHERWISE SPECIFIED ALL DIMENSIONS ARE INCHES [MM]	
TOLERANCES: EXCEPT AS NOTED	
INCHES	HOLDS
.X ± .10	ØX ± .10
.XX ± .020	ØXX ± .015
.XXX ± .015	ØXXX ± .010
APPROVALS	
DRAWN	HR
CHECKED	TW
APPROVED	

ADAM TECH
 909 Railway Avenue, Union, NJ 07083
 Phone: 908-687-5000 Fax: 908-687-5710

TITLE: HDMI CONNECTOR, RIGHT ANGLE, SURFACE MOUNT, NO PEG, FLANGE

SIZE	PART NO.	REV.
X	HDMI-S-PA4-SMT-MF-T/R	-
REF: S00097C	SCALE: NTS	SHEET 2 OF 2

6 5 4 3 2 1