

Rev	AWO #	Description	Date	Appr
-		RELEASED	6/08/10	

APPROVED: _____ TITLE: _____

DATE: _____

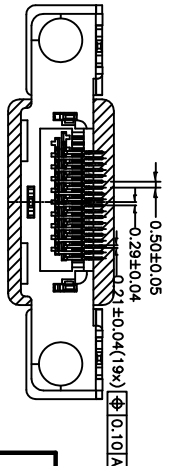
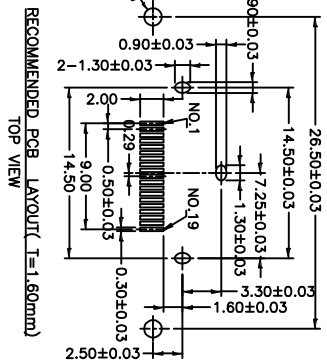
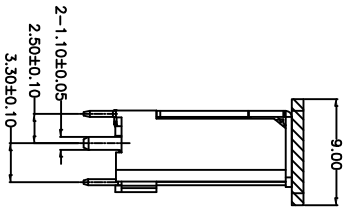
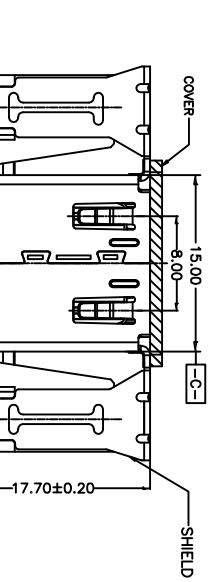
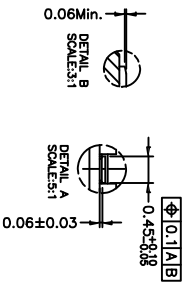
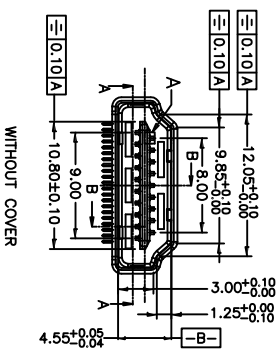
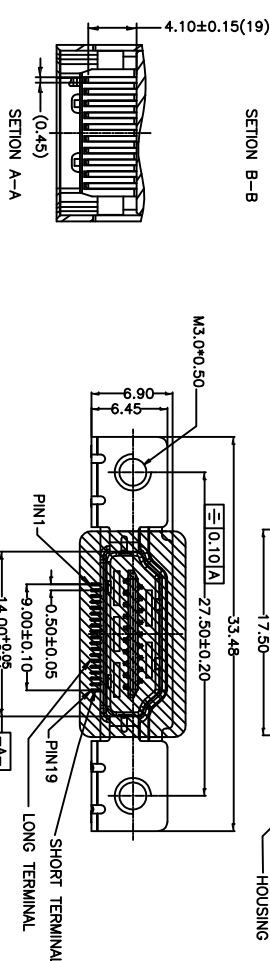
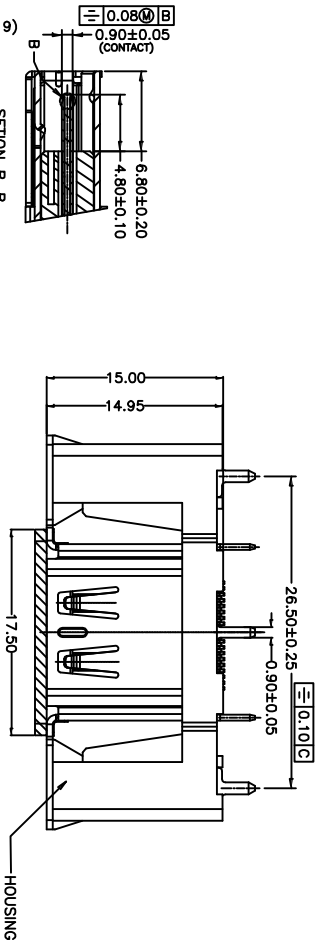

A B C D

SPECIFICATIONS:

Material:

Housing: Hi-temp thermoplastic, UL 94V-0

Housing color: Black

Contact: Copper Alloy

Shield: Copper Alloy, Nickel plated

Plating:

15u" Gold over Nickel underplate on contact area,

Tin over Copper underplate on tails.

Electrical:

Voltage rating: 40V

Current rating: 0.5A

Dielectric strength: 300VAC for 1 minute min.

Insulation resistance: 100 Megohm min.

Contact resistance: 10 mohms max.

Environmental:

Lead free, RoHS Compliant

Recommended soldering temp: 260°C for 5 seconds.

6

5

4

3

2

1

ADAM TECH

909 Rahway Avenue, Union, NJ 07083
Phone: 908-687-5000 Fax: 908-687-5710

TITLE: **HDMI CONNECTOR, 19P, VERTICAL, SMT**

UNLESS OTHERWISE SPECIFIED ALL DIMENSIONS ARE MM	
TOLERANCES: EXCEPT AS NOTED	
INCHES	HOLES
.X ± .10	ØX ± .10
.XX ± .020	ØXX ± .015
.XXX ± .015	ØXXX ± .010
APPROVALS	DATE
DRAWN DY	6/08/10
CHECKED	
APPROVED	

SIZE X	PART NO. HDMI-S-V-01-SMT-MF-15-KT	REV. -
REF: S00015C	SCALE: NTS	SHEET 1 OF 1

