

Rev	AWO #	Description	Date	Appr
-		RELEASED	5/25/15	

APPROVED: _____
 DATE: _____ TITLE: _____

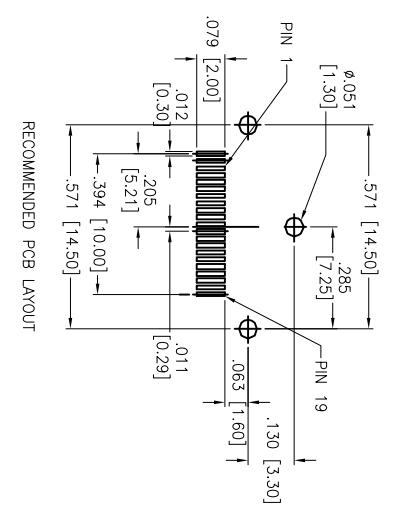
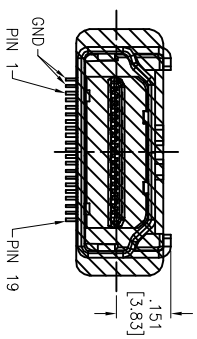
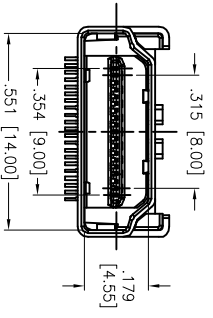
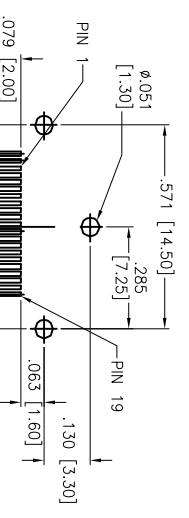
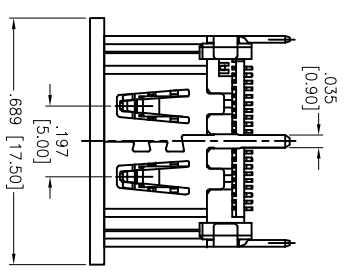

WITHOUT COVER

RECOMMENDED PCB LAYOUT

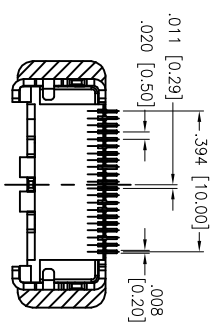
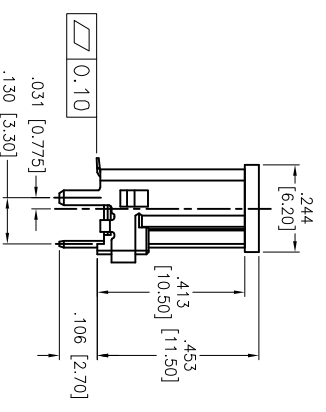
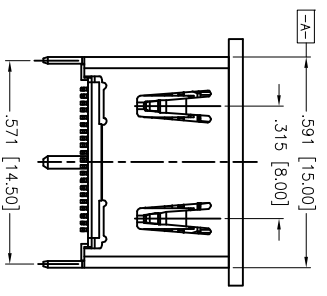

PACKAGED ON TAPE & REEL

SPECIFICATIONS:

Material:
 Insulator: Hi-Temp Thermoplastic, Glass reinforced, rated UL 94V-0
 Insulator color: Black
Contacts: Brass
 Shield: Brass, Nickel plated
Plating:
 Gold over Nickel underplate on contact area,
 Matte Tin over Copper underplate on PCB tails
Electrical:
 Operating voltage: 40 V
 Current rating: 0.5 A
 Contact resistance: 10 mohms max
 Insulation resistance: 100 Mohms min @ 500 VDC (Unmated)
 10 Mohms min @ 150 VDC (Mated)
Dielectric withstanding voltage: 300 VAC for 1 minute
Mechanical:
 Temperature Rating:
 Operating temperature: -20°C to +85°C
 Environmental:
 Lead free, RoHS compliant.

A

B

C

D

A

B

C

D

UNLESS OTHERWISE SPECIFIED
 ALL DIMENSIONS ARE INCHES [MM]
 TOLERANCES: EXCEPT AS NOTED
 INCHES
 .X ± .10
 .XX ± .020
 .XXX ± .015
 .XXX ± .010

ADAM TECH
 909 Railway Avenue, Union, NJ 07083
 Phone: 908-687-5000 Fax: 908-687-5710

APPROVALS	DATE
DRAWN	HR
CHECKED	CH
APPROVED	

SIZE	PART NO.	REV.
X	HDMM-S-V-02-SMT-DC-T/R	-
REF: S00005C	SCALE: NTS	SHEET 1 OF 1



6

5

4

3

2

1