

6

5

4

3

2

1

Rev	AWO #	Description	Date	Appr
-		RELEASED	11/18/14	

APPROVED: _____

DATE: _____ TITLE: _____

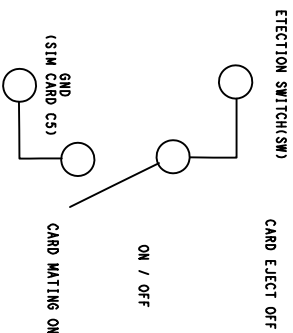
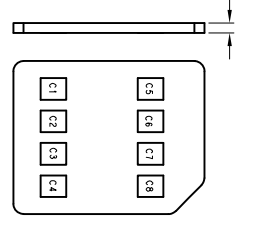
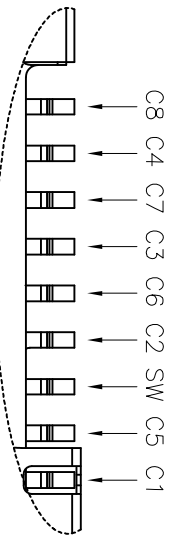
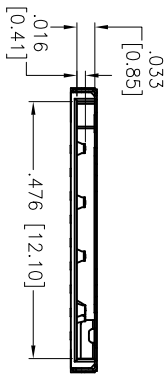
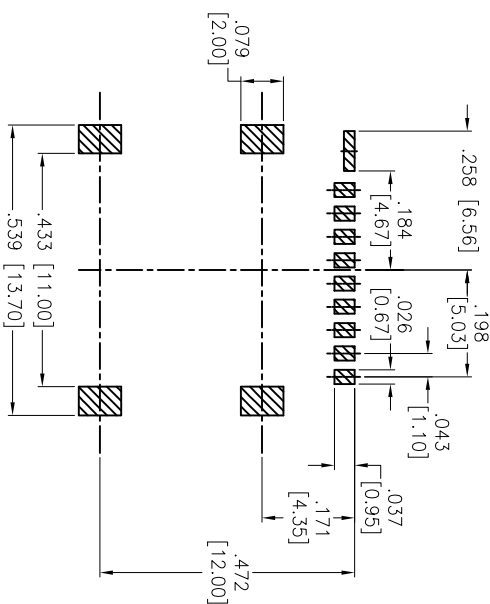
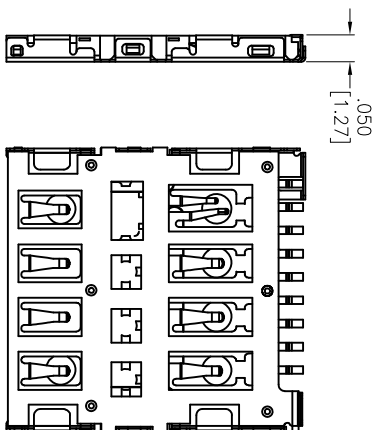
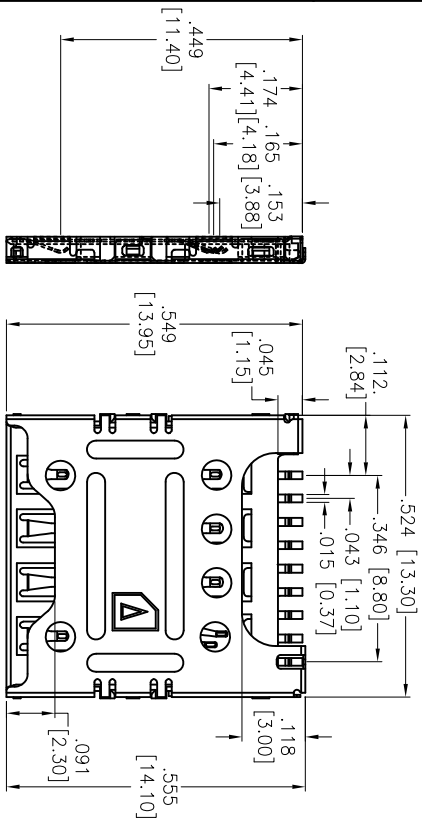
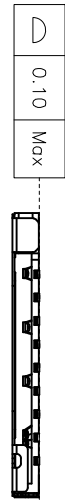

SW	DETECTION SWITCH
C8	RESERVED
C7	I/O
C6	VPP
C5	GND
C4	RESERVED
C3	CLK
C2	RST
C1	VCC
PIN No.	PIN NAME

SIM CARD PAD LAYOUT

PACKAGED ON TAPE & REEL

SPECIFICATIONS:

Material:
Insulation material: Thermoplastic Resin, UL94V-0, Color: Black
Contact material: Copper Alloy
Shell material: Stainless Steel, Gold plating at Soldering and Switch area
Plating:
Gold flash over Nickel underplate overall

Electrical:
Contact resistance: 50 mohms Max.
Insulation resistance: 1,000 Mohms min @ 500 VDC
Dielectric withstanding voltage: 1000 VAC for 1 minute
Temperature Rating:
Operating temperature: -40°C to +85°C

Environmental:
Lead free, RoHS compliant

Environmental:
Lead free, RoHS compliant

ADAM TECH
909 Railway Avenue, Union, NJ 07083
Phone: 908-687-5000 Fax: 908-687-5710

MICRO SIM CARD CONNECTOR
8 PIN, GOLD PLATED, TAPE & REEL

MSCC-D-08-G-SW-T/R

UNLESS OTHERWISE SPECIFIED ALL DIMENSIONS ARE INCHES [MM] TOLERANCES: EXCEPT AS NOTED	
INCHES	HOLDS
.X ± .10	ØX ± .10
.XX ± .020	ØXX ± .015
.XXX ± .015	ØXXX ± .010
APPROVALS	DATE
DRAWN HR	11/18/14
CHECKED GC	11/18/14
APPROVED	

REF: S00108C	SCALE: NTS	SHEET 1 OF 1
--------------	------------	--------------

6

5

4

3

2

1

A

B

C

D