

APPROVED: _____
 DATE: _____ TITLE: _____

Rev	AWO #	Description	Date	Appr
-	8155	RELEASED	7/21/09	
A	8155	UPDATED DIA & CHGD INSULATION RES	7/29/09	
B	8155	INSULATOR HOLE WAS .014"	7/30/09	
C	8155	REVISED SPEC.	9/25/09	
D	8155	UPDATED TOLERANCE BLOCK	1/27/10	

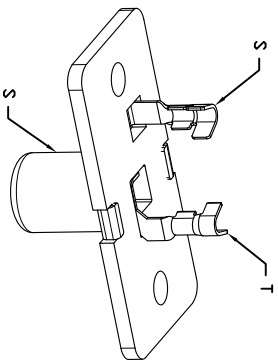
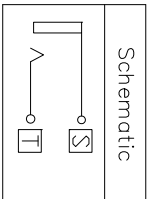
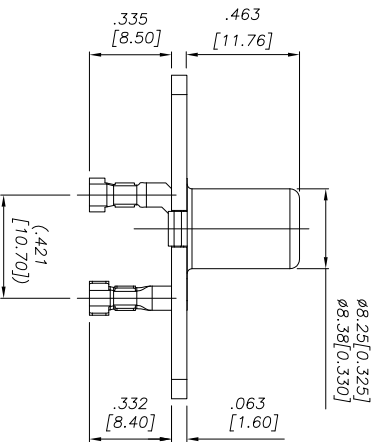
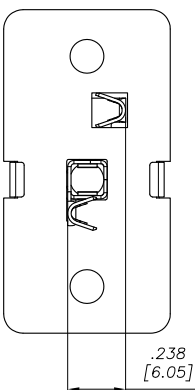
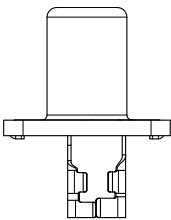
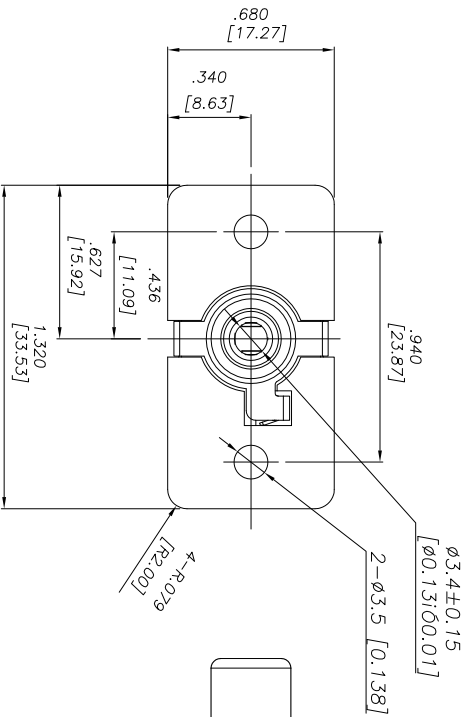
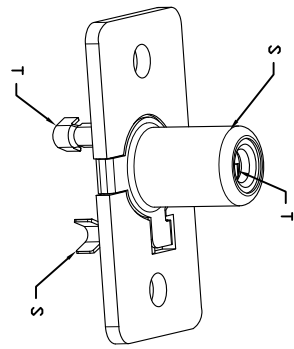

SPECIFICATIONS:

Material:
 Insulator: Hi-Temp Nylon 6T, UL 94V-0, color white
 (One piece design mounting plate / bushing)
 Bushing: Brass, Nickel Plated
 Contacts: Phosphor Bronze
 Contact plating:
 Tin over Copper underplate
Electrical:
 Voltage Rating: 540V DC max.
 Contact resistance: 30 mohms max.
 Insulation resistance: 100 Mohms min @1000V DC
 Dielectric withstanding voltage: 700 VAC for 1 minute
Mechanical:
 Life: 1000 Cycles
 Insertion / Withdrawal: 3-30N
 Recommended wire size: 22 - 24 Awg
Environmental:
 Temperature rating:
 Operating temperature: -40°C to +175°C
 Recommended soldering temp: 260°C for 5 sec.
 Lead free, RoHS compliant.

ADAM TECH

909 Railway Avenue, Union, NJ 07083
 Phone: 908-687-5000 Fax: 908-687-5710

RCA JACK, SINGLE PORT, VERTICAL,
 PANEL TYPE, CRIMP CONNECTIONS

UNLESS OTHERWISE SPECIFIED ALL DIMENSIONS ARE INCHES [MM] TOLERANCES: EXCEPT AS NOTED		TITLE	
X .10 ± .010	ØX ± .010	RCA JACK, SINGLE PORT, VERTICAL, PANEL TYPE, CRIMP CONNECTIONS	
XX .010 ± .005	ØXXX ± .005	SIZE	PART NO.
XXX .005 ± .005	ØXXXX ± .005	X	RCA-22-1-W-C3
APPROVALS		REF:	SCALE: NTS
DRAWN	SS	7/21/09	SHEET 1 OF 1
CHECKED			REV. D
APPROVED			