

6

5

4

3

2

1

APPROVED: _____

DATE: _____ TITLE: _____

Rev	AWO #	Description	Date	Appr
-		RELEASED	7/15/16	

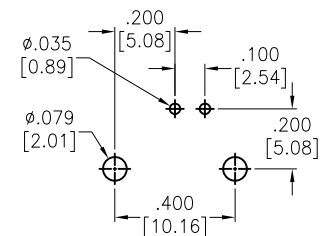
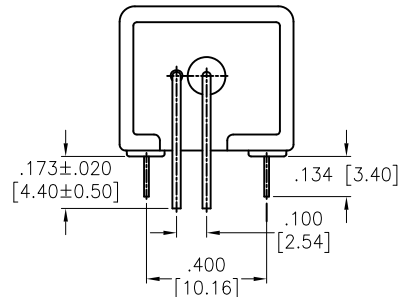
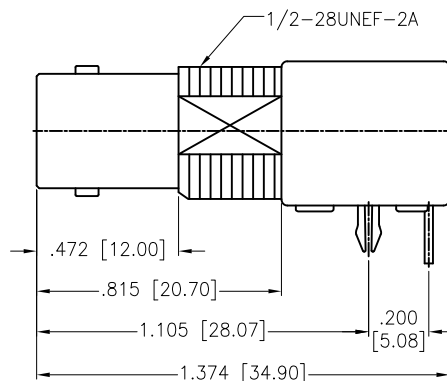
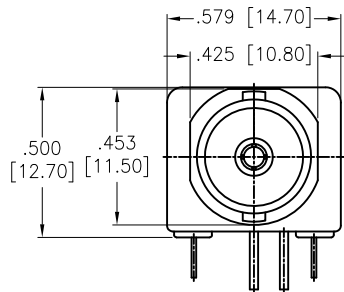

RECOMMENDED PCB HOLE

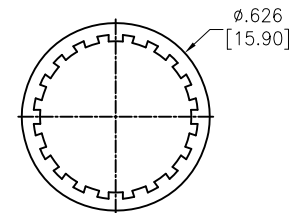
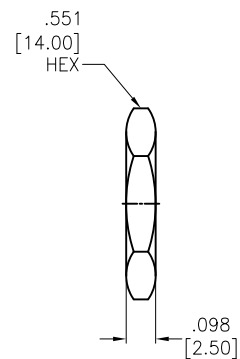
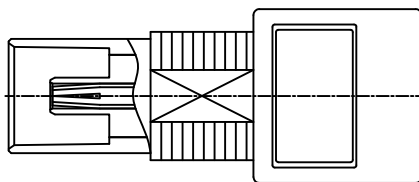

WASHER	STEEL	NICKEL
NUT	BRASS	NICKEL
SOLDER	PB CU	TIN
MOINTINC POST	PB CU	TIN
PIN	PB CU	GOLD 5u"
INSULATOR	POM	WHITE
BODY	ZINC	NICKEL
DESCRIPTION	MATERIAL	FINISH

A SPECIFICATIONS
 Electrical
 Nominal Impedance: 75 ohm
 Max Frequency: 1 GHz
 Temperature Rating:
 Operating temperature: -55°C to +85°C
 Environmental:
 Lead free, RoHS compliant



UNLESS OTHERWISE SPECIFIED ALL DIMENSIONS ARE MM [INCHES] TOLERANCES: EXCEPT AS NOTED		ADAM TECH 909 Rahway Avenue, Union, NJ 07083 Phone: 908-687-5000 Fax: 908-687-5710	
INCHES HOLES .X ±.10 Ø.X ±.10 .XX ±.020 Ø.XX ±.015 .XXX ±.015 Ø.XXX ±.010			
APPROVALS		TITLE	
DATE		RF CONNECTOR, TYPE BNC RIGHT ANGLE, PCB, 75 OHM	
DRAWN	HR	7/15/16	
CHECKED	AT	7/15/16	
APPROVED			
SIZE	PART NO.	REV.	
X	RF1-01C-D-00-75-HDW	-	
REF:	S00277T	SCALE:	NTS
		SHEET	1 OF 1

6

5

4

3

2

1